

Dual P-Channel Enhancement-Mode MOSFET

Product Summary

V_{DS} (V)	$r_{DS(on)}$ (Ω)	I_D (A)
-20	0.075 @ $V_{GS} = -4.5$ V	± 3.4
	0.105 @ $V_{GS} = -3.0$ V	± 2.9
	0.115 @ $V_{GS} = -2.7$ V	± 2.6

Recommended upgrade: Si9934DY

Lower profile/smaller size see: Si6943DQ

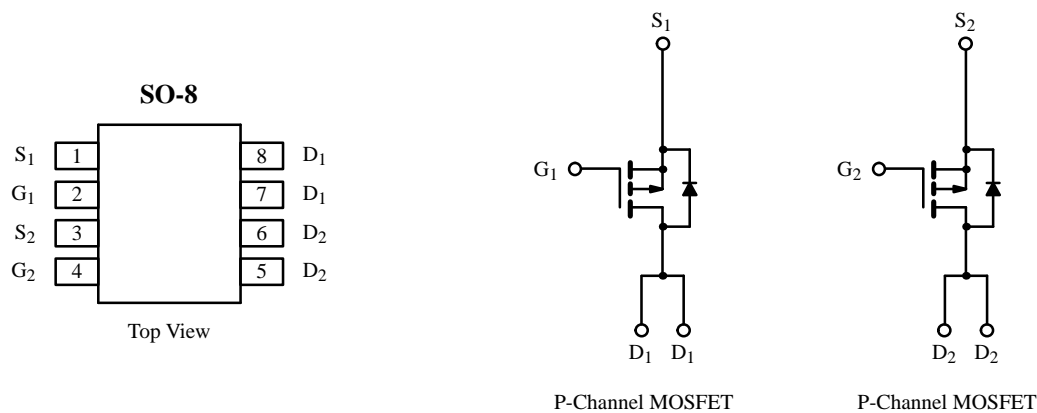

Absolute Maximum Ratings ($T_A = 25^\circ\text{C}$ Unless Otherwise Noted)

Parameter	Symbol	Limit	Unit
Drain-Source Voltage	V_{DS}	-20	V
Gate-Source Voltage	V_{GS}	± 12	
Continuous Drain Current ($T_J = 150^\circ\text{C}$) ^a	I_D	$T_A = 25^\circ\text{C}$	± 3.4
		$T_A = 70^\circ\text{C}$	± 2.7
Pulsed Drain Current	I_{DM}	± 16	A
Continuous Source Current (Diode Conduction) ^a	I_S	-2.0	
Maximum Power Dissipation ^a	P_D	$T_A = 25^\circ\text{C}$	
		$T_A = 70^\circ\text{C}$	1.3
Operating Junction and Storage Temperature Range	T_J, T_{stg}	-55 to 150	$^\circ\text{C}$

Thermal Resistance Ratings

Parameter	Symbol	Limit	Unit
Maximum Junction-to-Ambient ^a	R_{thJA}	62.5	$^\circ\text{C}/\text{W}$

Notes

a. Surface Mounted on FR4 Board, $t \leq 10$ sec.

Updates to this data sheet may be obtained via facsimile by calling Siliconix FaxBack, 1-408-970-5600. Please request FaxBack document #70651. A SPICE Model data sheet is available for this product (FaxBack document #70529).

Specifications ($T_J = 25^\circ\text{C}$ Unless Otherwise Noted)

Parameter	Symbol	Test Condition	Min	Typ ^a	Max	Unit
Static						
Gate Threshold Voltage	$V_{GS(th)}$	$V_{DS} = V_{GS}, I_D = -250 \mu\text{A}$	-0.8			V
Gate-Body Leakage	I_{GSS}	$V_{DS} = 0 \text{ V}, V_{GS} = \pm 12 \text{ V}$			± 100	nA
Zero Gate Voltage Drain Current	I_{DSS}	$V_{DS} = -16 \text{ V}, V_{GS} = 0 \text{ V}$			-1	μA
		$V_{DS} = -10 \text{ V}, V_{GS} = 0 \text{ V}, T_J = 85^\circ\text{C}$			-3	
On-State Drain Current ^b	$I_{D(on)}$	$V_{DS} \leq -5 \text{ V}, V_{GS} = -4.5 \text{ V}$	-16			A
		$V_{DS} \leq -5 \text{ V}, V_{GS} = -2.7 \text{ V}$	-3			
Drain-Source On-State Resistance ^b	$r_{DS(on)}$	$V_{GS} = -4.5 \text{ V}, I_D = -3.2 \text{ A}$		0.06	0.075	Ω
		$V_{GS} = -3.0 \text{ V}, I_D = -2.0 \text{ A}$		0.078	0.105	
		$V_{GS} = -2.7 \text{ V}, I_D = -1 \text{ A}$		0.085	0.115	
Forward Transconductance ^b	g_{fs}	$V_{DS} = -9 \text{ V}, I_D = -3.4 \text{ A}$		8		S
Diode Forward Voltage ^b	V_{SD}	$I_S = -2.0 \text{ A}, V_{GS} = 0 \text{ V}$		-0.7	-1.2	V
Dynamic^a						
Total Gate Charge	Q_g	$V_{DS} = -6 \text{ V}, V_{GS} = -4.5 \text{ V}, I_D = -3.2 \text{ A}$		10	20	nC
Gate-Source Charge	Q_{gs}			2.1		
Gate-Drain Charge	Q_{gd}			3.3		
Turn-On Delay Time	$t_{d(on)}$	$V_{DD} = -6 \text{ V}, R_L = 6 \Omega$ $I_D \cong -1 \text{ A}, V_{GEN} = -4.5 \text{ V}, R_G = 6 \Omega$		16	40	ns
Rise Time	t_r			46	80	
Turn-Off Delay Time	$t_{d(off)}$			40	70	
Fall Time	t_f			25	40	
Source-Drain Reverse Recovery Time	t_{rr}	$I_F = -2.0 \text{ A}, di/dt = 100 \text{ A}/\mu\text{s}$		60	100	

Notes

- a. For design aid only; not subject to production testing.
 b. Pulse test; pulse width $\leq 300 \mu\text{s}$, duty cycle $\leq 2\%$.

Typical Characteristics (25°C Unless Otherwise Noted)

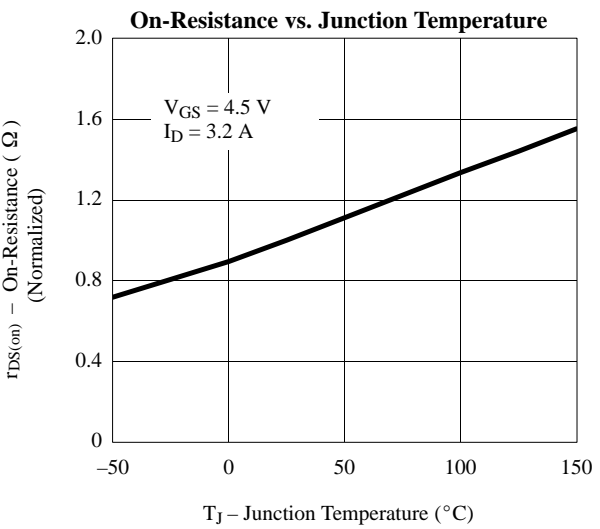
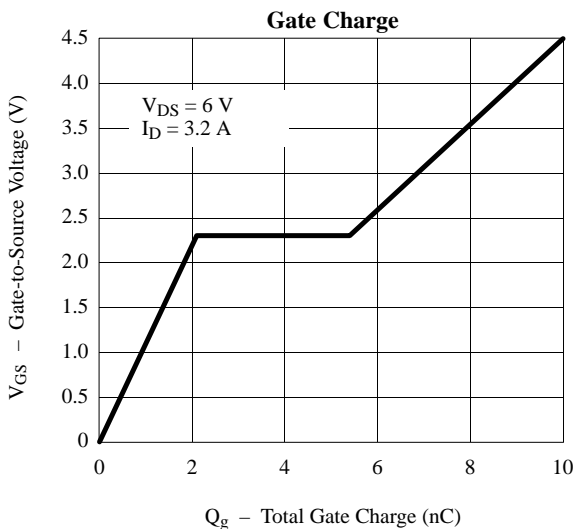
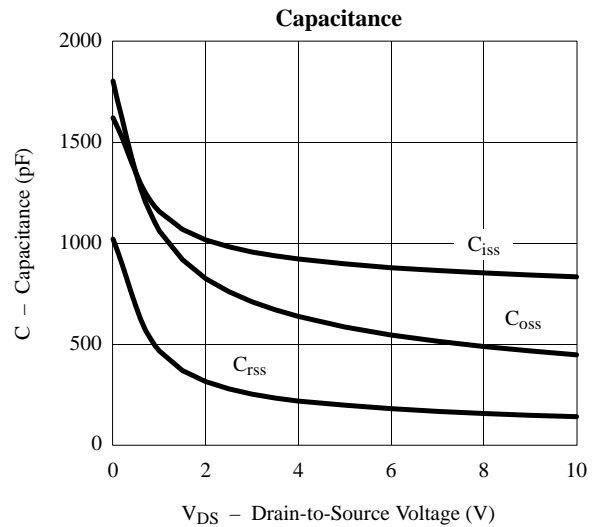
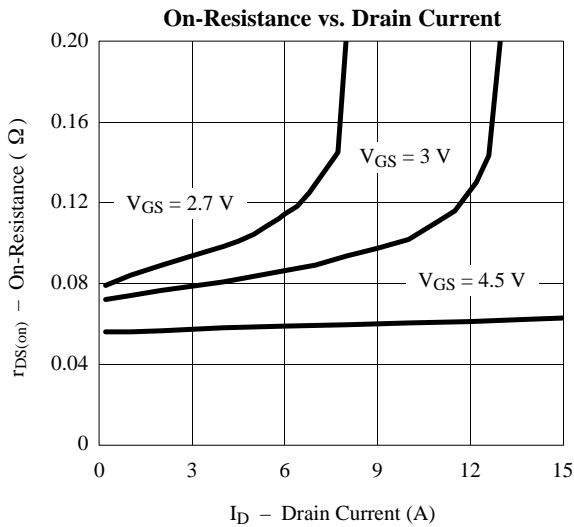
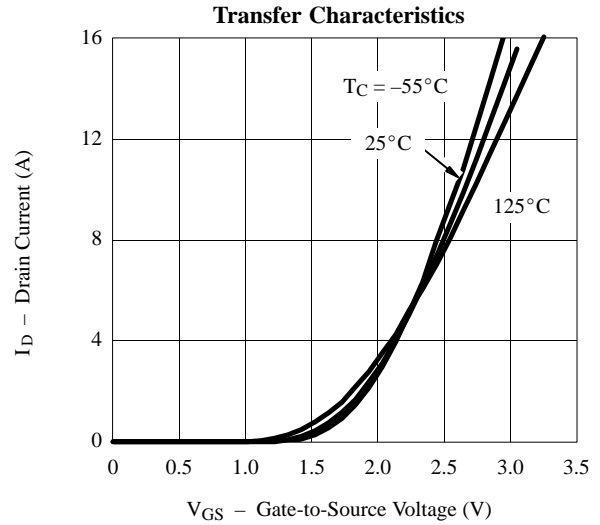
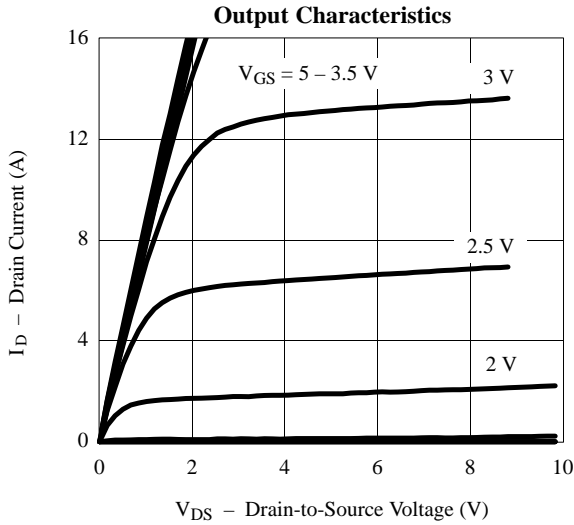

Typical Characteristics (25°C Unless Otherwise Noted)

